

"AMBIOPHONIC" SYSTEM
FM/AM COMPACT STEREO
with CASSETTE TAPE RECORDER
& AUTOMATIC RECORD CHANGER
MODEL SDT-3431
SERVICE MANUAL



No. 6 4 6

1 9 7 4

SPECIFICATIONS

RADIO CIRCUIT SYSTEM.....FM/AM superheterodyne
with FM multiplex stereo adaptor
TUNING RANGE.....FM: 88~108 MHz
AM: 530~1,605kHz

IC

IC201 TRM1205.....FM IF Amp. & AM Conv.
IC202 TRM1212.....FM/AM IF Amp.
IC301 SN76110.....MPX.
IC501A, B STK011.....Power Amp.
IC701A, B FA6018Pre-amp.
IC702A, B FA6019Pre-amp.

TRANSISTORS

Q101 2SK37.....FM RF Amp.
Q102 2SC535.....FM Conv.
Q401A, B 2SC458LG.....AF Amp.
Q701 2SB77}.....Biass OSC.
Q702 2SB77}

DIODES

D101 HV80.....FM Limiter
D102 1S85.....AFC
D103 HV 80.....FM Limiter
D151 HV 80.....AM AGC
D201 HV 80.....FM Limiter
D202 1N60P}.....FM Disc.
D203 1N60P}
D204 1N34A.....AM Det.
D205 1N60}.....Rect. for tuning meter
D206 1N60}
D601 AW01-13.....Voltage stabilizer
D701A, B 1N34A.....Rect. for automatic level control
D702A, B 1N34A.....Rect. for level meter

CR601 VO6C }
CR602 VO6C }.....Rectifier
CR603 VO6C }
CR604 VO6C }

TAPE.....Compact cassette

TAPE SPEED.....1 $\frac{7}{8}$ ips (4.75cm/sec.)

RECORDING OR PLAYING TIME.....60min (using C-60)

RECORDING SYSTEM.....AC bias

ERASING SYSTEM.....AC erase

TRACK SYSTEM.....Stereo 4 track

SPEAKER.....6 $\frac{1}{2}$ " (16cm) Woofer \times 2

2" (5cm) Tweeter \times 2

AUDIO OUTPUT.....15W \times 2 (P.M.P)

FREQUENCY RANGE.....40~20,000Hz

POWER SUPPLY.....AC: 120V 60Hz

POWER CONSUMPTION.....80W

INPUT IMPEDANCE.....AUX. IN: 180k Ω

MIC. IN: 5k Ω

OUTPUT IMPEDANCE.....REC. OUT: 15k Ω

FRONT SPEAKER: 8 Ω

REAR SPEAKER: 8 Ω

HEADPHONE: 8 Ω

MICROPHONE.....Dynamic microphone

ANTENNA.....FM: Line cord antenna

AM: Built-in ferrite-core antenna

SENSITIVITY.....FM: 7 μ V (practical)

AM: 250 μ V (practical)

DIMENSIONS.....Radio: 9 $\frac{1}{2}$ "(H) \times 24 $\frac{3}{4}$ "(W) \times 14 $\frac{1}{8}$ "(D)

WEIGHT.....Radio: 29 lbs. 4 oz. (13.3kg)

ACCESSORIES

DYNAMIC MICROPHONE..... 1
COMPACT CASSETTE (C-30)..... 1

CONTROLS

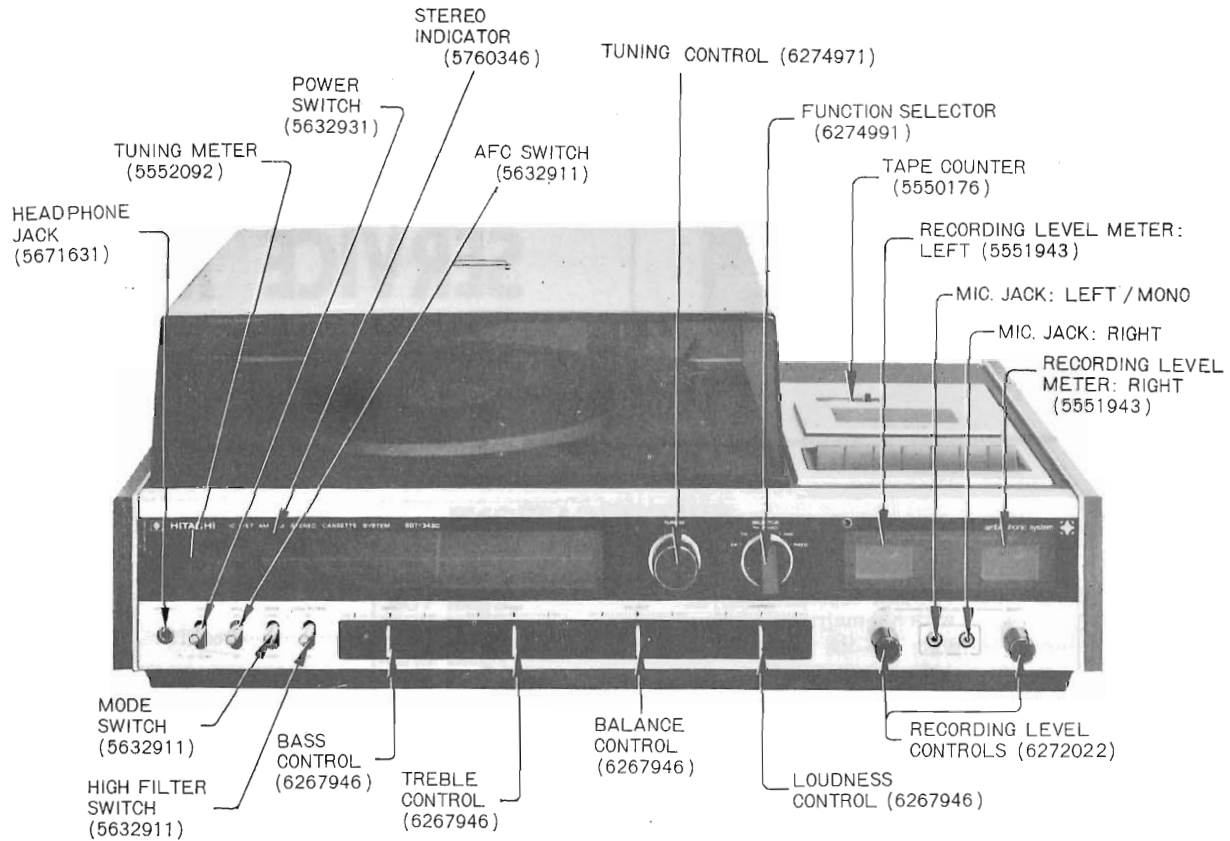

Fig. 1

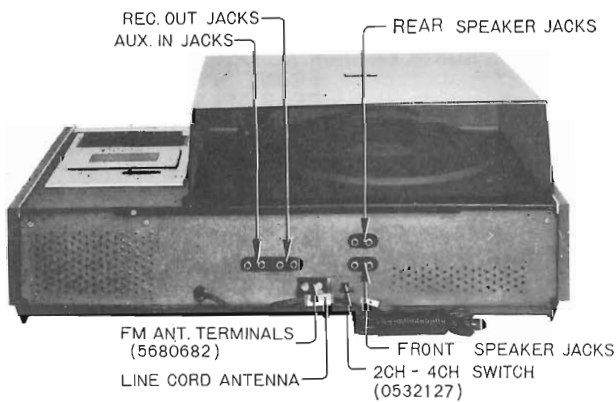

Fig. 2

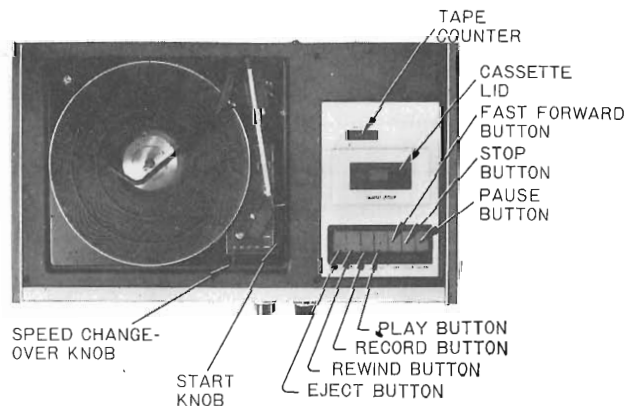

Fig. 3

BLOCK DIAGRAM

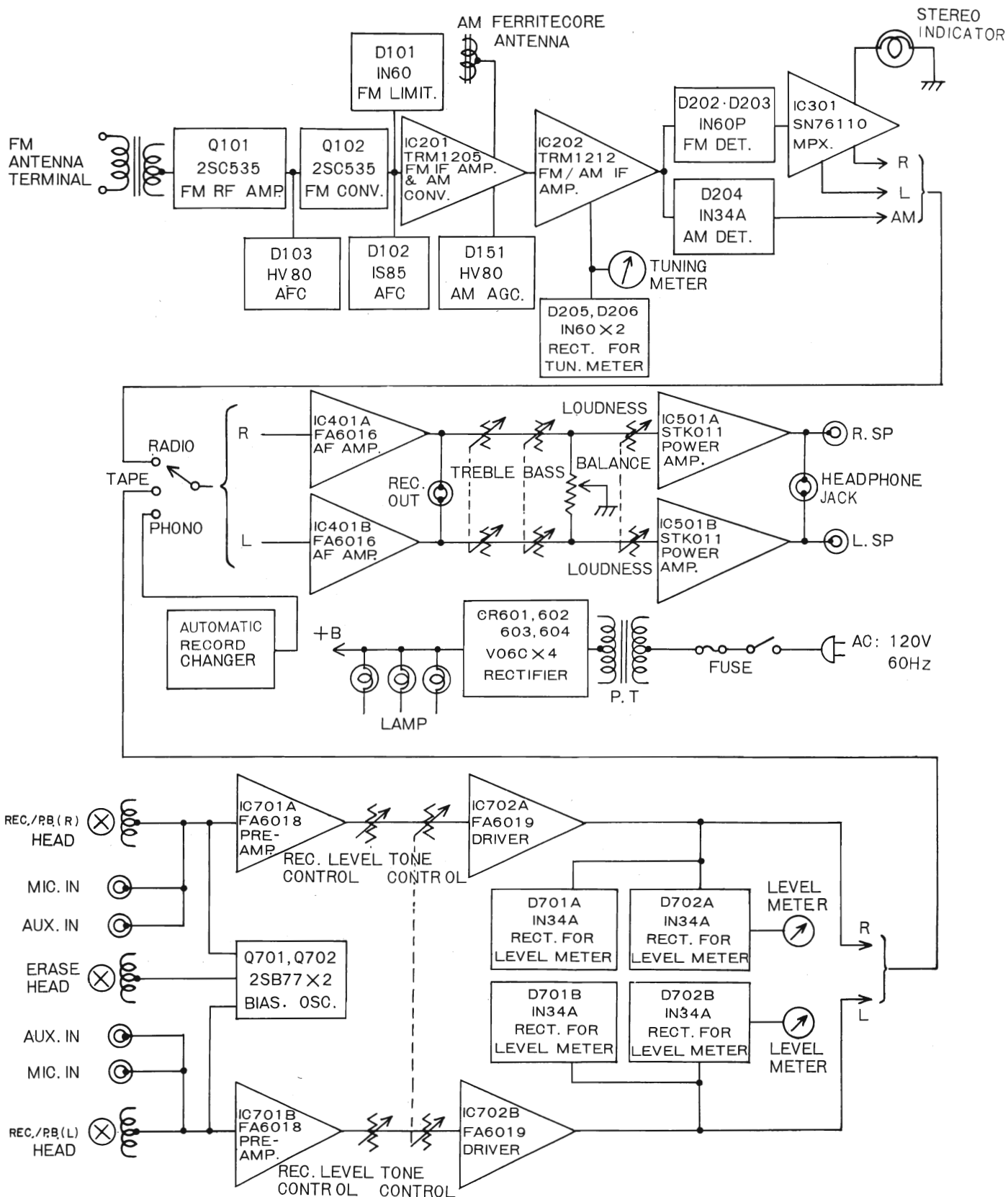

Fig. 4

DISASSEMBLY

1. Removal of rear cover (6191142)

Loosen FM antenna terminal screw.
Remove the terminal lug of the line cord antenna from the right screw.
Remove three screws holding rear cover as shown in Fig. 5.

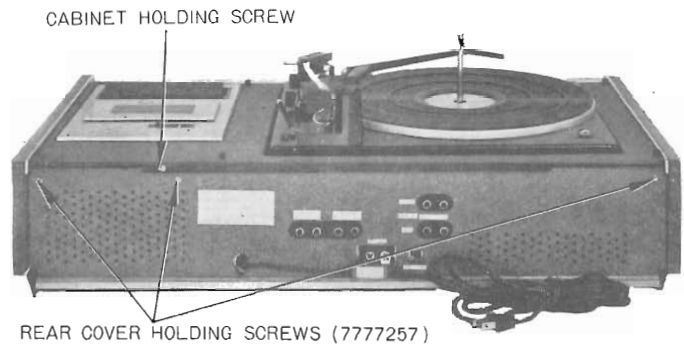

Fig. 5

2. Removal of cabinet (7125212)

Remove five screws holding cabinet as shown in Figs. 5 and 6.

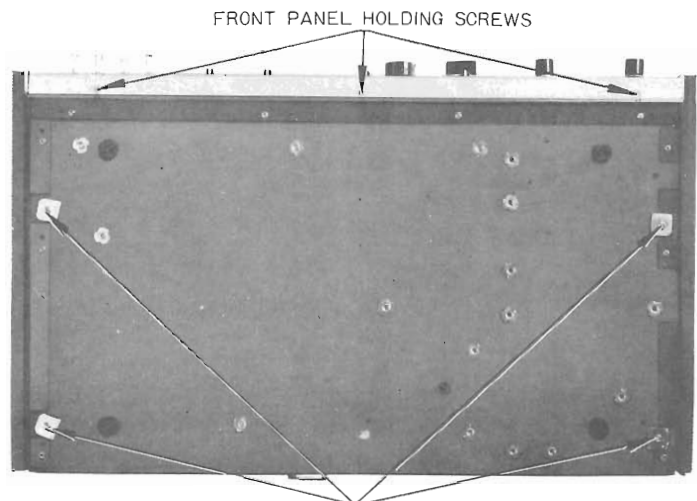

Fig. 6

3. Removal of front panel

After pulling out eight knobs, remove six screws holding front panel as shown in Figs. 6 and 7.

4. Removal of chassis

Remove nine screws holding chassis as shown in Fig. 7.

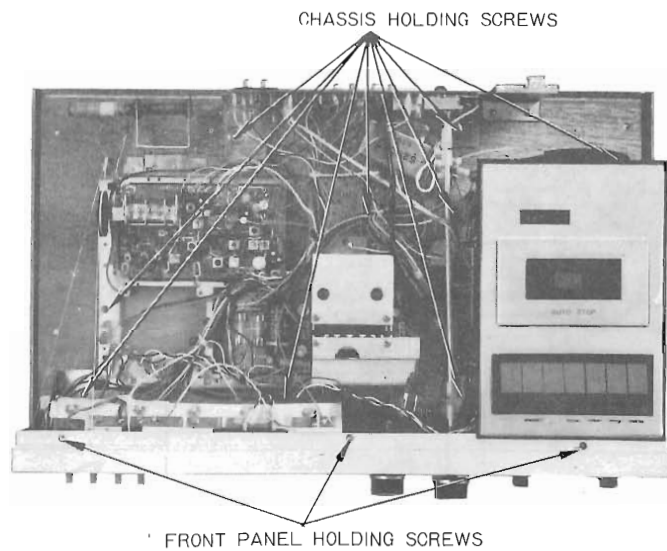

Fig. 7

5. Removal of HF-2 circuit board (RF-IF circuit board)

Remove five screws holding HF-2 circuit board as shown in Fig. 8.

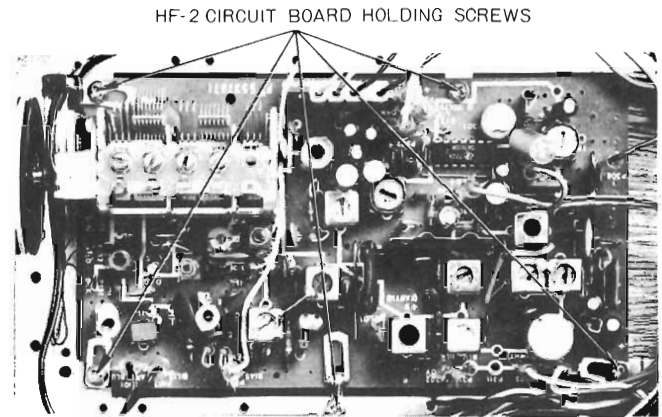

Fig. 8

6. Removal of AF circuit board

After remove three screws holding radiator, remove six screws holding AF circuit board as shown in Fig. 9.

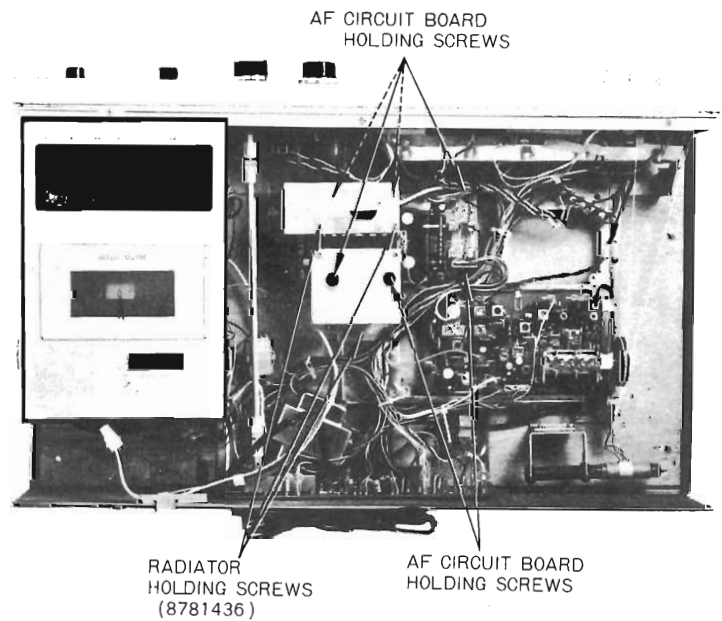
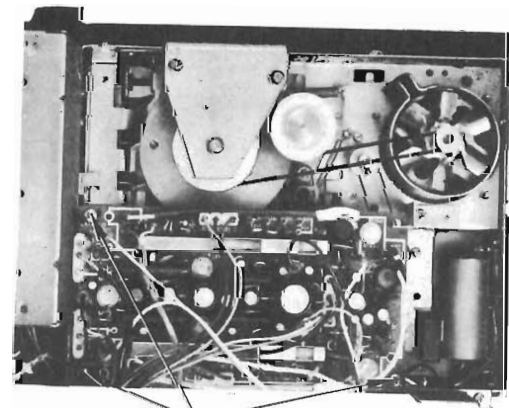

Fig. 9

7. Removal of PRE-AMP. circuit board

Remove three screws holding PRE-AMP. circuit board as shown in Fig. 10.



PRE-AMP. CIRCUIT BOARD
HOLDING SCREWS

Fig. 10

8. Removal of TONE circuit board

Remove eight screws holding TONE circuit board as shown in Fig. 11.

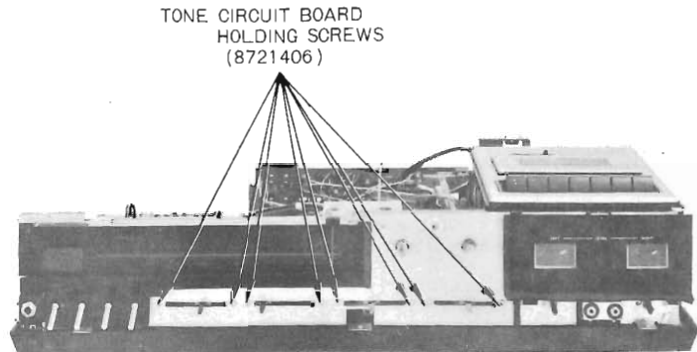

Fig. 11

9. Removal of JACK circuit board

Remove three screws holding JACK circuit board as shown in Fig. 12.

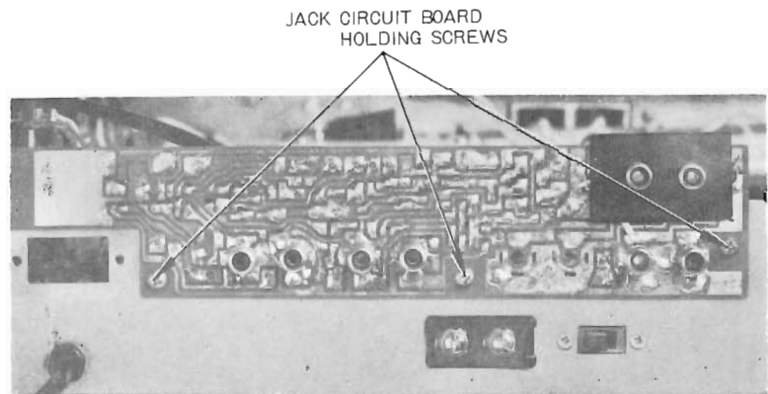

Fig. 12

10. Removal of deck upper cover

Remove of six screws holding deck up cover as shown in Figs. 13 and 14.

DECK UPPER COVER
HOLDING SCREWS
(8745410)

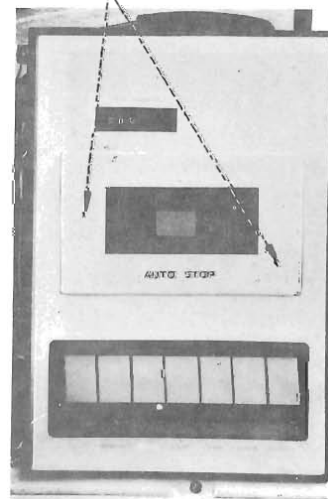

Fig. 13

DECK UPPER COVER
HOLDING SCREWS

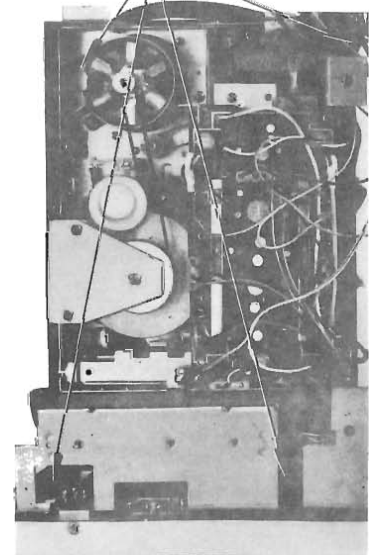

Fig. 14

DIAL CORD STRINGING

Referring to Fig. 15, loop the dial cord in the direction of arrows.

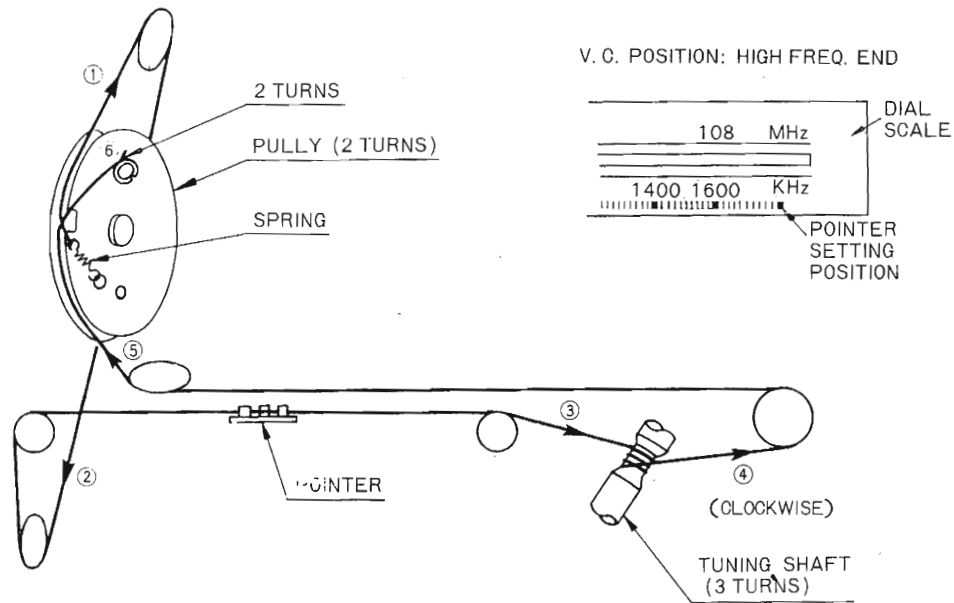

Fig. 15

LUBRICATION

One or two drops of machine oil may be applied to the point Ⓜ (rotating parts), grease may be applied to the point ⓐ

(sliding surfaces) as shown in Figs.16 and 17.

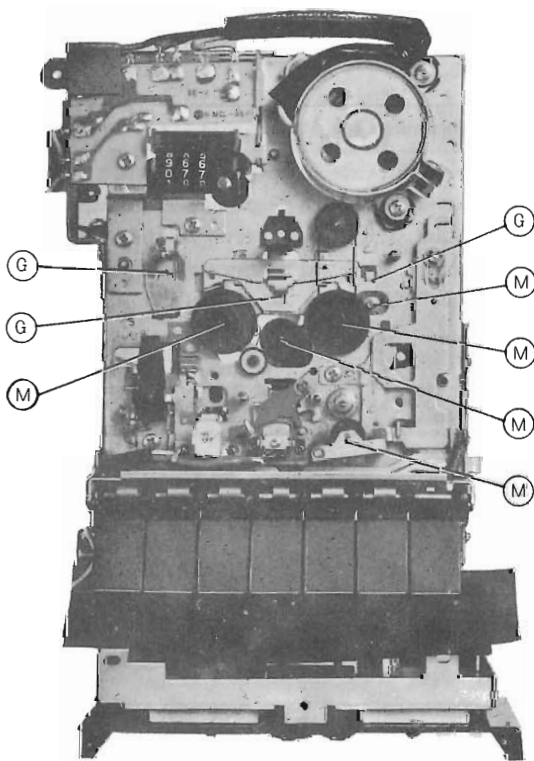

Fig. 16

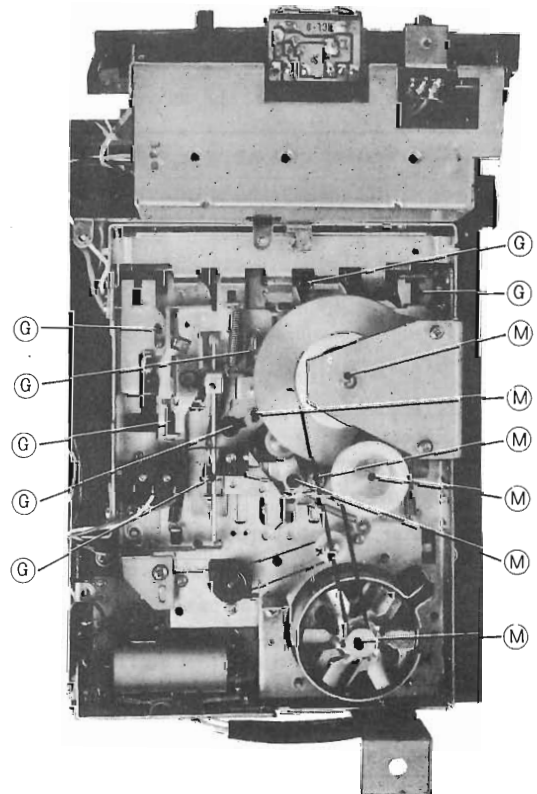

Fig. 17

ADJUSTMENT AND INSPECTION

RADIO CIRCUIT

Instrument Required

◦ Signal

1. RF Signal Generator (FM, AM)
2. IF Sweep Generator (Centered 455kHz for AM and 10.7MHz for FM)
3. Marker Generator

◦ Output Indicator

1. VTVM (AC 3V or less scale)
2. Oscilloscope

General Preparation

1. Insert power cord plug into AC outlet (120V, 60Hz) and check power supply voltage.

2. Turn the volume control knob to maximum.

Note: During FM-IF and FM-DISC. alignment, turn the volume to minimum.

3. During AM alignment, connect output of signal generator (modulated by 400Hz or 1,000Hz 30%) to a loop antenna (4 inches in diameter, 2 or 3 turns) and couple the loop antenna to the ferrite-core antenna.

Connect the VTVM to the speaker terminals.

During FM-RF alignment, connect output of signal generator to FM antenna terminals using a dummy antenna as shown in Fig. 18.

4. Adjust with an insulated screw driver to prevent body effect.
5. The order of adjustment is shown below. As the reading of the VTVM. rises in proportion to adjustment, adjust the output of speaker terminals may not exceed 3V at maximum.

FM-IF Alignment

- Oscilloscope: Connect VERT. terminal of high gain oscilloscope to P308.
- Sweep Generator: Connect to R104 through 0.001 μ F coupling capacitor.
- Marker Generator: Loosely couple to sweep generator.
- Adjust as indicated until the waveform as shown in Fig.19 is obtained.

Step	Dial Pointer Setting	Sig. Gen. Output	Adjustment for Max. Output
①	High freq. end	10.7MHz \pm 1MHz sweep	Detune T204 and then adjust T203, T202, T201, T103, T102
②	Repeat step ①		

FM-DISC. Alignment

- Oscilloscope, Sweep Generator and Marker generator connect same as FM-IF alignment. Then, adjust as follows until the waveform as shown in Fig. 20 is obtained.

Step	Dial Pointer Setting	Sig. Gen. Output	Adjustment for Max. Output
①	High freq. end	10.7MHz \pm 1MHz sweep	T204 for waveform centered at 10.7MHz maker. Adjust T204 until waveform maximum and minimum points are at the same distance from horizontal line as shown Fig. 20 and until maximum and minimum points and 10.7MHz point on waveform are on a straight line.
②	Repeat step ①		

AM-IF Alignment

- Signal Generator: Couple output of AM signal generator to set through loop antenna.
- VTVM: Connect AC probe to speaker terminals.
- Adjust as indicated for maximum reading on VTVM.

Step	Dial Pointer Setting	Sig. Gen. Output	Adjustment for Max. Output
①	High freq. end	455kHz	T206, T205, T151
②	Repeat step ①		

AM-RF Alignment

- Signal Generator and VTVM, connect same as AM-IF alignment.
- Adjust as indicated for maximum reading on VTVM.

Step	Dial Pointer Setting	Sig. Gen. Output	Adjustment for Max. Output
①	Low freq. end	520kHz	L152
②	High freq. end	1,650kHz	CT152
③	Repeat steps ① and ②		
④	600kHz signal	600kHz	L151 (position coil on bar)
⑤	1,400kHz signal	1,400kHz	CT151
⑥	Repeat steps ④ and ⑤		

FM-RF Alignment

- Signal Generator: Connect to FM antenna terminal.
- VTVM: Connect same as AM-IF alignment.
- Adjust as indicated for maximum reading on VTVM.

Step	Dial Pointer Setting	Sig. Gen. Output	Adjustment for Max. Output
①	Low freq. end	87MHz	L105
②	High freq. end	109MHz	CT103
③	Repeat steps ① and ②		
④	90MHz signal	90MHz	L103
⑤	108MHz signal	108MHz	CT102
⑥	Repeat steps ④ and ⑤		

TAPE DECK**Adjustment of bias current**

- Measure the voltage drop at both ends of R701A,B (10Ω) with VTVM.
- Adjust RV704A,B (220kΩ) so that the VTVM. reads 1.2mV.

Adjustment of the recording and playback head angle

- Prepare a standard tape for angle adjustment and adjust the screw for angle adjustment so that the output is maximum as shown in Fig. 22.

Adjustment of the power switch and muting switch

(Fig. 23)

- Adjust the screw for bar switch adjustment and the screw for lever spring adjustment so that the muting switch may be ON after the power switch is ON in the play button is pressed, contact point of muting switch should be apart 0.2mm or more in the play button is lock and the power switch should be OFF in stop condition.

Adjustment of flywheel thrust gap

Adjust the screw for flywheel thrust gap adjustment within the range of 0.1~0.5mm.

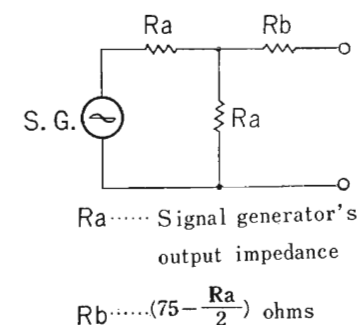

Fig. 18

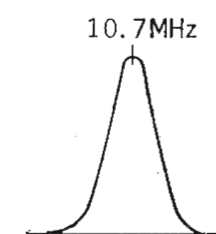

Fig. 19

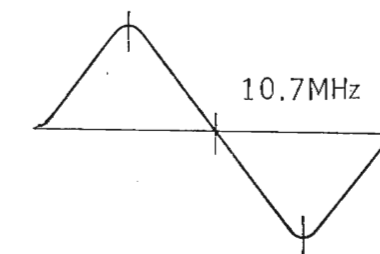

Fig. 20

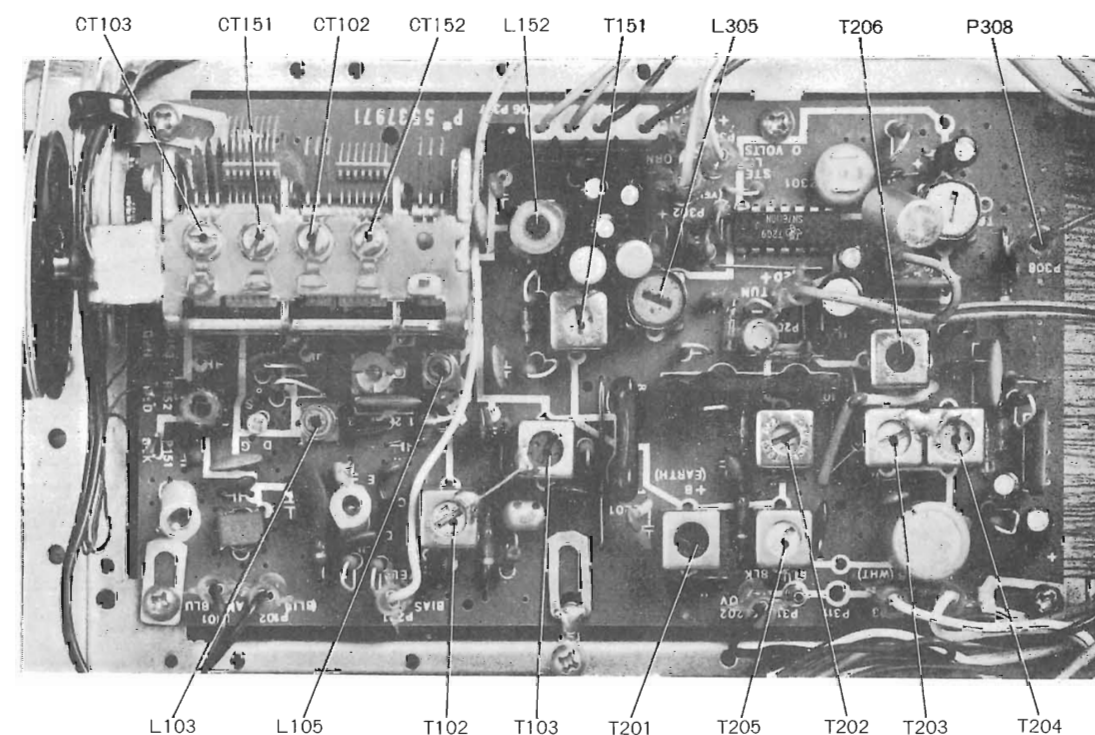
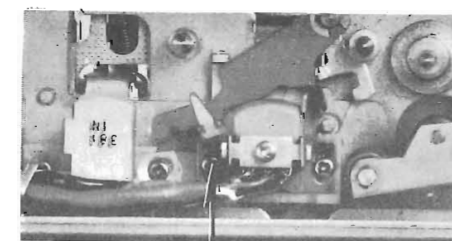

Fig. 21



ANGLE ADJUSTMENT SCREW (8715112)

Fig. 22

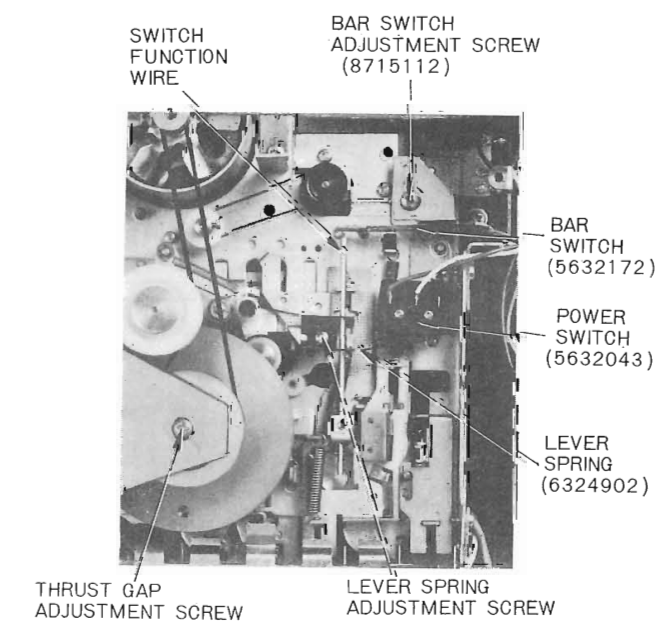
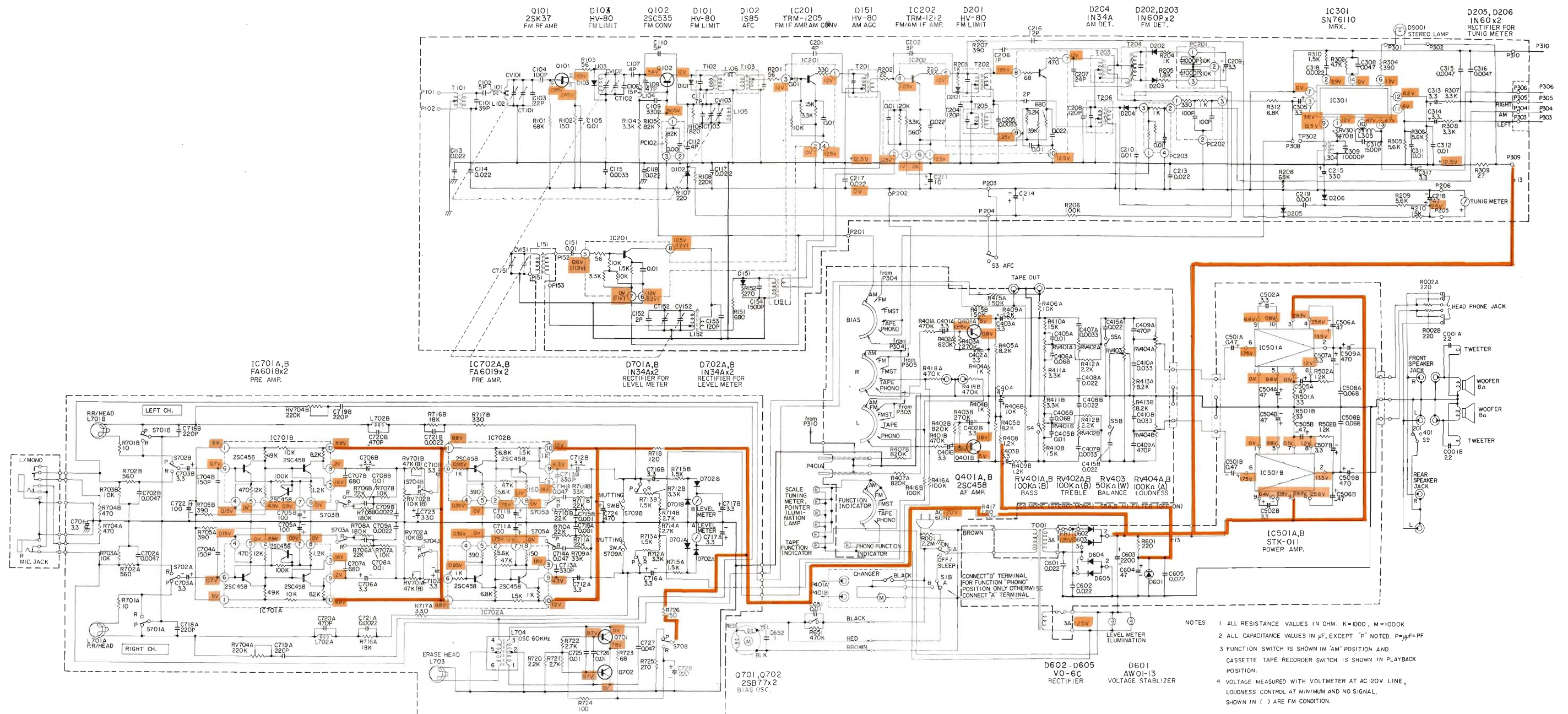

Fig. 23

SCHMATIC DIAGRAM



- NOTES
1. ALL RESISTANCE VALUES IN OHM. K=1000, M=1000K
 2. ALL CAPACITANCE VALUES IN μ F, EXCEPT "P" NOTED. P= μ F=PF
 3. FUNCTION SWITCH IS SHOWN IN "AM" POSITION AND CASSETTE TAPE RECORDER SWITCH IS SHOWN IN PLAYBACK POSITION.
 4. VOLTAGE MEASURED WITH VOLTMETER AT AC 120V LINE, LOUDNESS CONTROL AT MINIMUM AND NO SIGNAL. SHOWN IN () ARE FM CONDITION.

CIRCUIT BOARD DIAGRAM

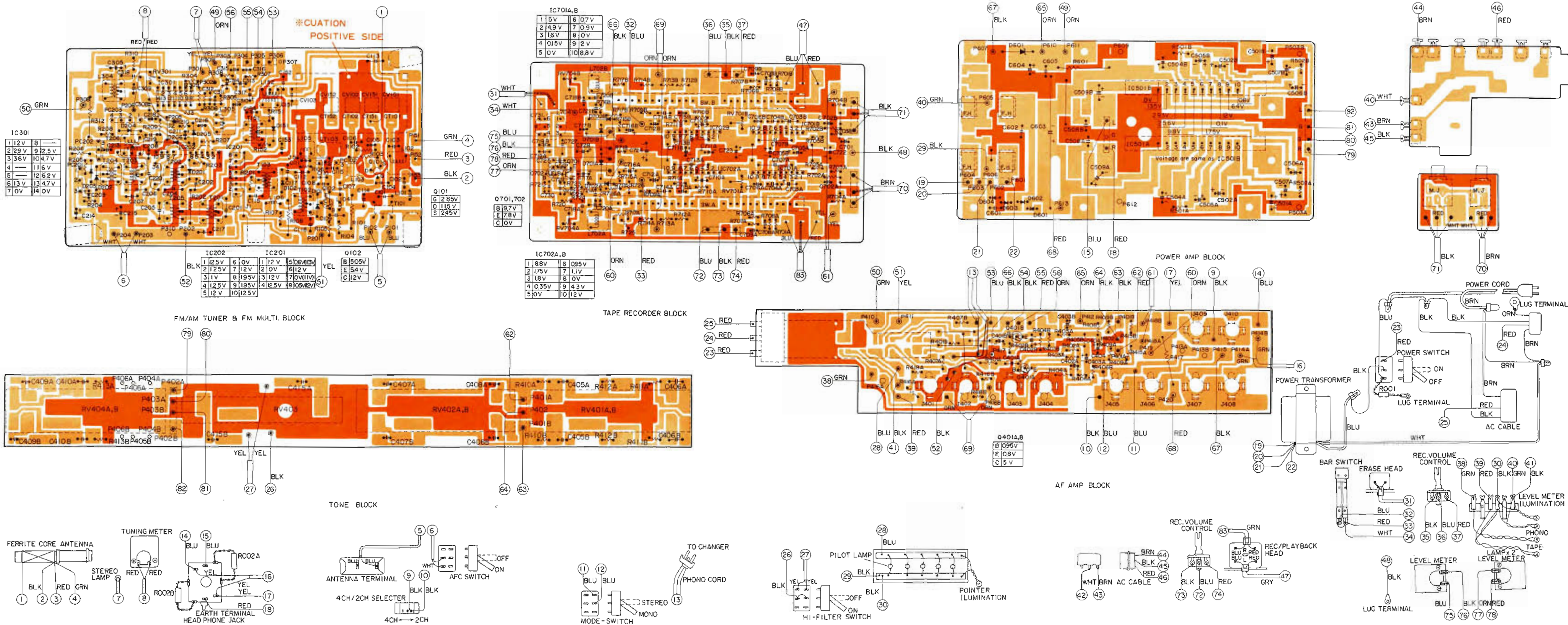

EXPLODET VIEW

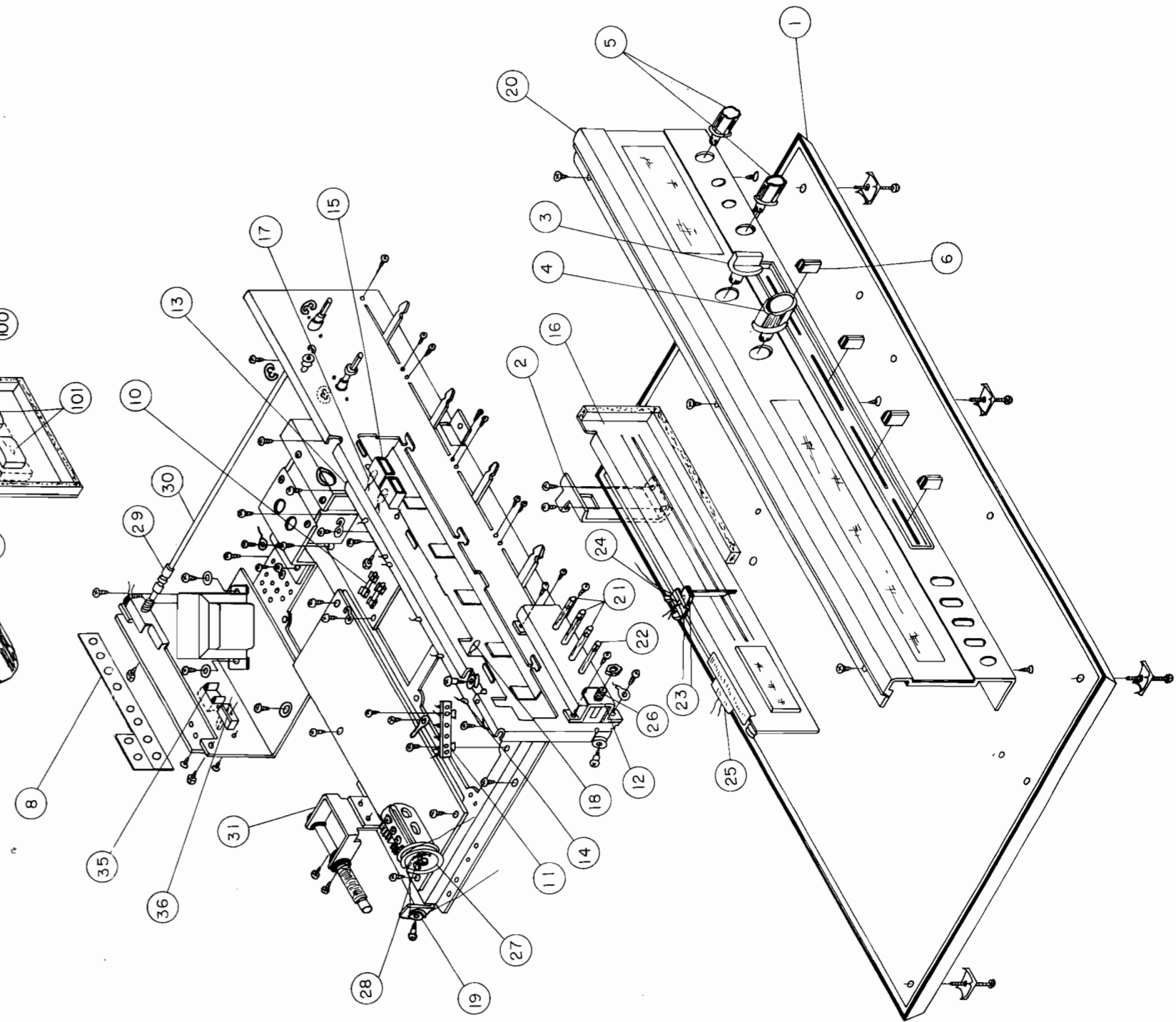
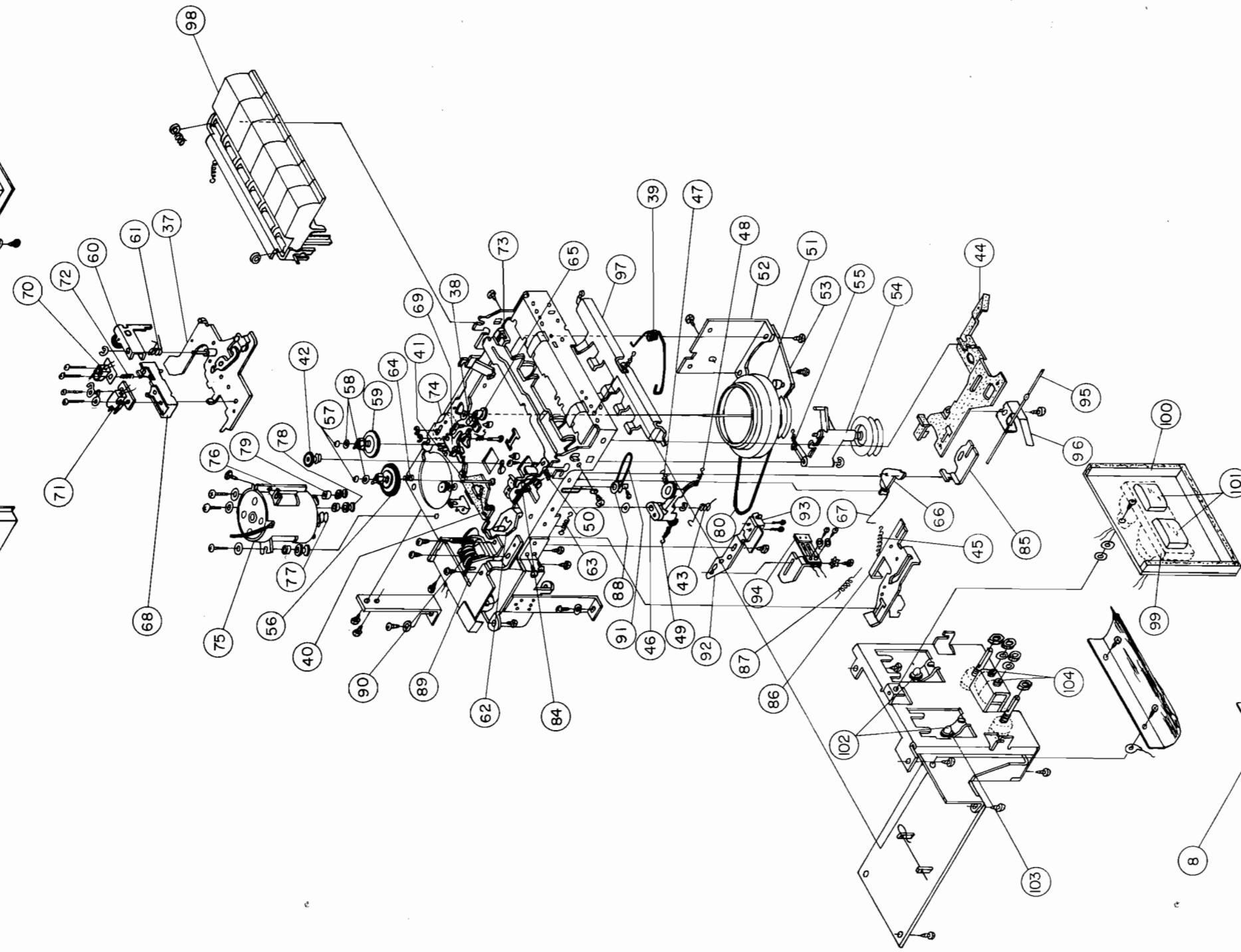
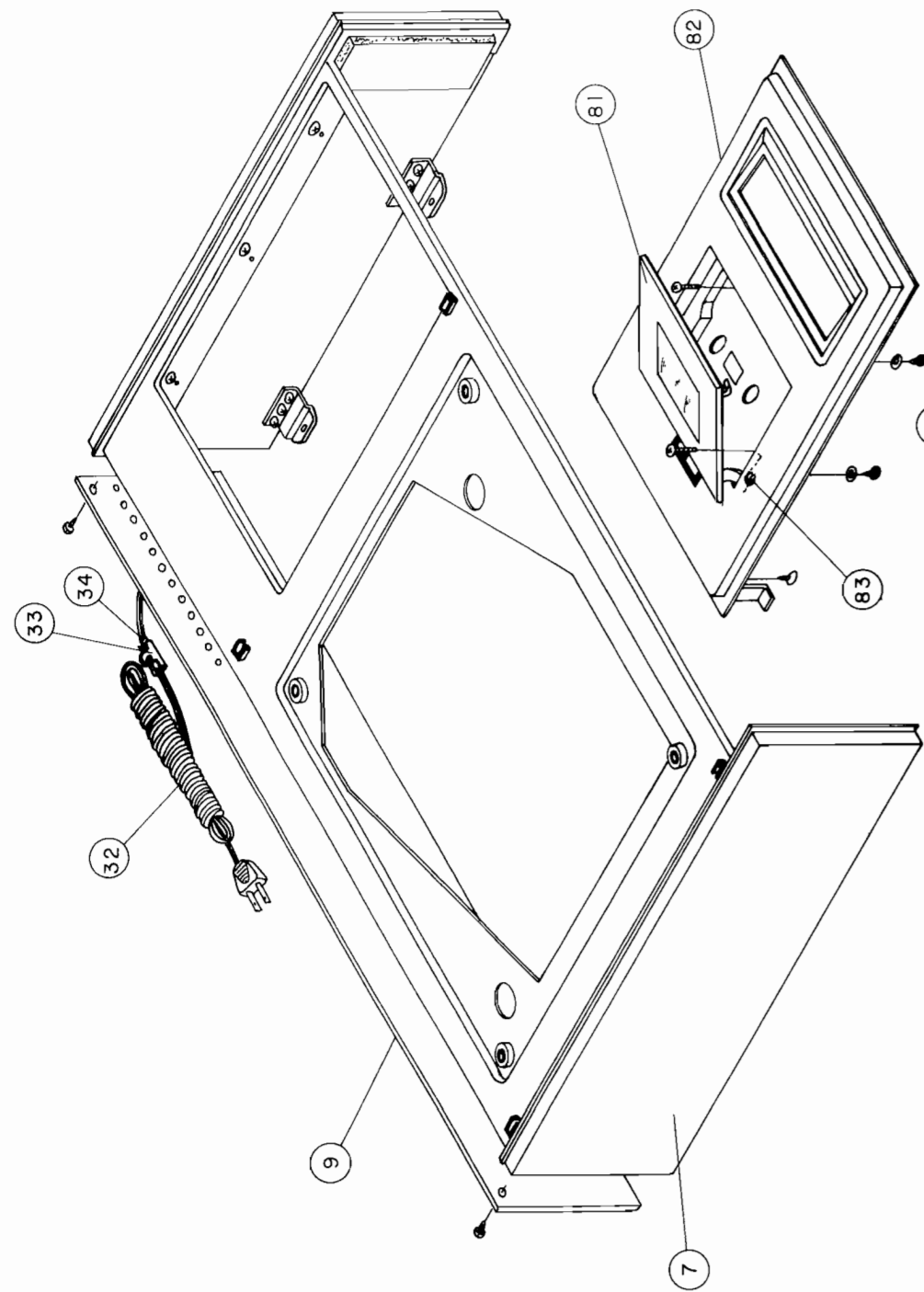

REPLACEMENT PARTS

Symbol No.	Stock No.	Description	Symbol No.	Stock No.	Description	Symbol No.	Stock No.	Description
CAPACITORS:								
C001A,B	0256501	Electrolytic		2.2 μ F	16V	C415A,B	0275113	Mylar 0.022 μ F \pm 20%
C 101	0248714	Ceramic, discal		39pF \pm 10%		C501A,B	0257040	Electrolytic 0.47 μ F
C 102	0248645	Ceramic, discal		5pF \pm 0.5pF		C502A,B	0252613	Electrolytic 3.3 μ F
C 103	0248668	Ceramic, discal		22pF \pm 5%		C504A,B	0252525	Electrolytic 47 μ F
C 104	0248724	Ceramic, discal		100pF \pm 10%		C505A,B	0252525	Electrolytic 47 μ F
C 105	0244171	Ceramic, discal		0.01 μ F \pm 80% -20%		C506A,B	0252625	Electrolytic 47 μ F
C 106	0248704	Ceramic, discal		15pF \pm 10%		C507A,B	0252613	Electrolytic 3.3 μ F
C 107	0248644	Ceramic, discal		4pF \pm 0.5pF		C508A,B	0275116	Mylar 0.068 μ F \pm 20%
C 108	0248716	Ceramic, discal		47pF \pm 10%		C509A,B	0256008	Electrolytic 470 μ F
C 109	0248696	Ceramic, discal		330pF \pm 5%		C 601	0275113	Mylar 0.022 μ F \pm 20%
C 110	0248645	Ceramic, discal		5pF \pm 0.5pF		C 602	0275113	Mylar 0.022 μ F \pm 20%
C 111	0248477	Ceramic, discal		7pF \pm 0.5pF		C 603	0256099	Electrolytic 2200 μ F
C 112	0248644	Ceramic, discal		4pF \pm 0.5pF		C 604	0252525	Electrolytic 47 μ F
C 113	0249512	Ceramic, discal		0.022pF \pm 0.5pF		C 605	0275113	Mylar 0.022 μ F \pm 20%
C 114	0249512	Ceramic, discal		0.022pF \pm 0.5pF		C 701	0252613	Electrolytic 3.3 μ F
C 115	0249507	Ceramic, discal		0.0033pF \pm 0.5pF		C702A,B	0274115	Mylar 0.0047 μ F \pm 20%
C 117	0249507	Mylar		0.022 μ F \pm 20%		C703A,B	0252613	Electrolytic 3.3 μ F
C 118	0275113	Mylar		0.022 μ F \pm 20%		C704A,B	0248728	Ceramic, discal 150pF \pm 10%
C 151	0244171	Ceramic, discal		0.01 μ F \pm 80% -20%		C705A,B	0252231	Electrolytic 100 μ F
C 152	0249532	Ceramic, discal		2pF \pm 0.5pF		C706A,B	0252613	Electrolytic 3.3 μ F \pm 20%
C 153	0248726	Ceramic, discal		120pF \pm 10%		C707A,B	0249530	Ceramic, discal 680pF \pm 5%
C 154	0217823	Styrol		1500pF \pm 5%		C708A,B	0275011	Mylar 0.01 μ F \pm 10%
C 201	0248644	Ceramic, discal		4pF \pm 0.5pF		C709A,B	0274013	Mylar 0.0022 μ F \pm 10%
C 202	0248643	Ceramic, discal		3pF \pm 0.5pF		C710A,B	0252613	Electrolytic 3.3 μ F
C 204	0248726	Ceramic, discal		120pF \pm 10%		C711A,B	0252231	Electrolytic 100 μ F
C 205	0274114	Mylar		0.0033 μ F \pm 20%		C712A,B	0252613	Electrolytic 3.3 μ F
C 206	0248641	Ceramic, discal		1pF \pm 0.5pF		C713A,B	0248736	Ceramic, discal 330pF \pm 10%
C 207	0248669	Ceramic, discal		24pF \pm 5%		C714A,B	0275015	Mylar 0.047 μ F \pm 10%
C 208	0248726	Ceramic, discal		120pF \pm 10%		C715A,B	0274011	Mylar 0.001 μ F \pm 10%
C 209	0252613	Electrolytic		3.3 μ F	25V	C716A,B	0252613	Electrolytic 3.3 μ F
C 210	0275111	Mylar		0.01 μ F \pm 20%	25V	C717A,B	0252613	Electrolytic 3.3 μ F
C 211	0252621	Electrolytic		10 μ F	25V	C718A,B	0248732	Ceramic, discal 220pF \pm 10%
C 213	0275113	Mylar		0.022 μ F \pm 20%	25V	C719A,B	0248732	Ceramic, discal 220pF \pm 10%
C 214	0252611	Electrolytic		1 μ F	25V	C720A,B	0249521	Ceramic, discal 470pF \pm 10%
C 215	0252533	Electrolytic		330 μ F	16V	C721A,B	0274013	Mylar 0.0022 μ F \pm 10%
C 216	0248702	Ceramic, discal		12pF \pm 10%		C 722	0252531	Electrolytic 100 μ F
C 217	0275113	Mylar		0.022 μ F \pm 20%	16V	C 723	0252533	Electrolytic 330 μ F
C 218	0252525	Electrolytic		47 μ F	16V	C 724	0256008	Electrolytic 470 μ F
C 219	0274111	Mylar		0.001 μ F \pm 20%	25V	C 725	0275111	Mylar 0.01 μ F \pm 10%
C 305	0252613	Electrolytic		3.3 μ F	25V	C 726	0275111	Mylar 0.01 μ F \pm 10%
C 308	0275115	Mylar		0.047 μ F \pm 20%		C 727	0275015	Mylar 0.047 μ F \pm 10%
C 309	0217825	Styrol		10000pF \pm 5%		C 728	0252332	Electrolytic 220 μ F
C 310	0217823	Styrol		1500pF \pm 5%		CV101~		
C 311	0275111	Mylar		0.01 μ F \pm 20%		152		
C 312	0275111	Mylar		0.01 μ F \pm 20%		CT101~	0281583	Variable capacitor
C 313	0252613	Electrolytic		3.3 μ F	25V	152		
C 314	0252613	Electrolytic		3.3 μ F	25V	C T 103	0283113	Trimmer
C 315	0274115	Mylar		0.0047 μ F \pm 20%		RESISTORS:		
C 316	0274115	Mylar		0.0047 μ F \pm 20%		R 001	0134477	Composition 2.2M Ω \pm 10%
C 317	0252613	Electrolytic		3.3 μ F	25V	R002A,B	0134365	Composition 220 Ω \pm 10%
C 318	0274113	Mylar		0.0022 μ F \pm 20%		R 101	0170281	Carbon film 68k Ω \pm 10%
C401A,B	0252613	Electrolytic		3.3 μ F	25V	R 102	0137803	Carbon film 150 Ω \pm 10%
C402A,B	0252613	Electrolytic		3.3 μ F	25V	R 103	0137768	Carbon film 56 Ω \pm 10%
C403A,B	0252613	Electrolytic		3.3 μ F	25V	R 104	0137857	Carbon film 3.3k Ω \pm 10%
C 404	0252525	Electrolytic		47 μ F	16V	R 105	0137912	Carbon film 82k Ω \pm 10%
C405A,B	0275111	Mylar		0.01 μ F \pm 20%		R 106	0137812	Carbon film 820 Ω \pm 10%
C406A,B	0275116	Mylar		0.068 μ F \pm 20%		R 107	0137805	Carbon film 220 Ω \pm 10%
C407A,B	0274114	Mylar		0.0033 μ F \pm 20%		R 108	0170295	Carbon film 220k Ω \pm 10%
C408A,B	0275113	Mylar		0.022 μ F \pm 20%		R 151	0137811	Carbon film 680 Ω \pm 10%
C409A,B	0249521	Ceramic, discal		470pF \pm 10%		R 152	0137806	Carbon film 270 Ω \pm 10%
C410A,B	0275114	Mylar		0.033 μ F \pm 20%		R 201	0137768	Carbon film 56 Ω \pm 10%
						R 202	0170215	Carbon film 22 Ω \pm 10%
						R 203	0137851	Carbon film 1k Ω \pm 10%
						R 204	0137851	Carbon film 1k Ω \pm 10%
						R 205	0137854	Carbon film 1.8k Ω \pm 10%

SDT-3431

Symbol No.	Stock No.	Description			Symbol No.	Stock No.	Description		
R 206	0137951	Carbon film	100kΩ±10%	¼SD	RV	0171555	Slide variable	100kΩ(B)	
R 207	0137808	Carbon film	390Ω±10%	¼SD	401A,B				
R 208	0114531	Carbon film	68kΩ±10%	¼P	RV	0171554	Slide variable	100kΩ(A)	
R 209	0137860	Carbon film	5.6kΩ±10%	¼SD	402A,B				
R 210	0137903	Carbon film	15kΩ±5%	¼SD	R V 403	0171528	Slide variable	50kΩ(W)	
R 304	0137808	Carbon film	390Ω±10%	¼SD	RV	0171561	Slide variable	100kΩ(A)	
R 305	0137860	Carbon film	5.6kΩ±10%	¼SD	404A,B				
R 306	0137860	Carbon film	5.6kΩ±10%	¼SD	RV	0151888	Semi variable	47kΩ(B)	
R 307	0114467	Carbon film	3.3kΩ±10%	¼P	701A,B				
R 308	0114467	Carbon film	3.3kΩ±10%	¼P	RV702A	0151410	Variable	10kΩ(B)	
R 309	0137764	Carbon film	27Ω±10%	¼SD	RV702B	0151410	Variable	10kΩ(B)	
R 310	0137853	Carbon film	1.5kΩ±10%	¼SD	RV	0151890	Semi variable	220kΩ(B)	
R 312	0114471	Carbon film	6.8kΩ±10%	¼P	704A,B				
R 401A,B	0137951	Carbon film	100kΩ±10%	¼SD	SEMI-CONDUCTORS:				
R 402A,B	0131812	Composition	820kΩ±10%	¼GF	Q 101	5320702	Transistor	2SK37	Silicon 200MHz 100mW
R 403A,B	0137956	Carbon film	270kΩ±10%	¼SD	Q 102	0573511	Transistor	2SC535C	Silicon 100MHz200mW
R 404A,B	0137851	Carbon film	1kΩ±10%	¼SD	Q401A,B	5320024	Transistor	2SC458(LG)D	Silicon 10kHz 200mW
R 405A,B	0137862	Carbon film	8.2kΩ±10%	¼SD	Q 701	0573004	Transistor	2SB77/B/P	Germanium 10kHz 150mW
R 406A,B	0137901	Carbon film	10kΩ±10%	¼SD	Q 702	0573004	Transistor	2SB77/B/P	Germanium 10kHz 150mW
R 407A,B	0137812	Composition	820kΩ±10%	¼GF	I C 201	5354541	IC	TRM1205	
R 409A,B	0137852	Carbon film	1.2kΩ±10%	¼SD	I C 202	5354601	IC	TRM1212	
R 410A,B	0137903	Carbon film	15kΩ±10%	¼SD	I C 301	5351042	IC	SN76110	
R 411A,B	0137857	Carbon film	3.3kΩ±10%	¼SD	IC	5353141	Power IC	STK-011	
R 412A,B	0137855	Carbon film	2.2kΩ±10%	¼SD	501A,B				
R 413A,B	0137862	Carbon film	8.2kΩ±10%	¼SD	IC	5353111	Hybrid IC	FA6018	
R 415A,B	0137953	Carbon film	150kΩ±10%	¼SD	IC	5353121	Hybrid IC	FA6019	
R 416A,B	0137951	Carbon film	100kΩ±10%	¼SD	D 101	5330261	Diode	HV-80	Silicon 100MHz 20mW
R 417	0111409	Metal oxide	180Ω±10%	2PB	D 102	0575024	Diode	1S85	Silicon 10MHz
R 418A,B	0137717	Carbon film	470kΩ±10%	¼SD	D 103	5330261	Diode	HV-80	Silicon 100MHz 20mW
R 501A,B	0137765	Carbon film	33Ω±10%	¼SD	D 151	5330261	Diode	HV-80	Silicon 100MHz 20mW
R 502A,B	0137902	Carbon film	12kΩ±10%	¼SD	D 201	5330261	Diode	HV-80	Silicon 100MHz 20mW
R 601	0171209	Metal oxide	220Ω±10%	2FB	D 202	0575019	Diode	1N60P	Germanium 10.7MHz
R 701A,B	0137759	Carbon film	10Ω±10%	¼SD	D 203	0575019	Diode	1N60P	Silicon 10MHz
R 702A,B	0137810	Carbon film	560Ω±10%	¼SD	D 204	0575001	Diode	1N34A	Germanium 455kHz
R 703A,B	0137901	Carbon film	10kΩ±10%	¼SD	D 205	0575005	Diode	1N60	Germanium 10.7MHz
R 704A,B	0137809	Carbon film	470Ω±10%	¼SD	D 206	0575005	Diode	1N60	Germanium 10.7MHz
R 705A,B	0137808	Carbon film	390Ω±10%	¼SD	D 601	5330054	Zener diode	AW01-13	Silicon 100kHz 1W
R 706A,B	0137905	Carbon film	22kΩ±10%	¼SD	D				
R 707A,B	0137901	Carbon film	10kΩ±10%	¼SD	601~604	5330101	Rectifier	VO6C	
R 708A,B	0137954	Carbon film	180kΩ±10%	¼SD	D701A,B	0575001	Diode	1N34A	Germanium 455kHz
R 709A,B	0137907	Carbon film	33kΩ±10%	¼SD	D702A,B	0575001	Diode	1N34A	Germanium 455kHz
R 710A,B	0137905	Carbon film	22kΩ±10%	¼SD	TRANSFORMERS:				
R 711A,B	0137905	Carbon film	22kΩ±10%	¼SD	T 001	5211335	Power(800g 41VA)		
R 712A,B	0137857	Carbon film	3.3kΩ±10%	¼SD	T 101	0318543	FM antenna		
R 713A,B	0137853	Carbon film	1.5kΩ±10%	¼SD	T 102	0322236	FM IFT	10k:0.3k	
R 714A,B	0137856	Carbon film	2.7kΩ±10%	¼SD	T 103	5142007	FM IFT	6.8k:0.56k	
R 715A,B	0137853	Carbon film	1.5kΩ±10%	¼SD	T 151	5132002	AM IFT		
R 716A,B	0137904	Carbon film	18kΩ±10%	¼SD	T 201	0322203	FM IFT		
R 717A,B	0137807	Carbon film	330Ω±10%	¼SD	T 202	0329602	FM IFT		
R 718	0137802	Carbon film	120Ω±10%	¼SD	T 203	0326026	FM Discriminator		
R 720	0137855	Carbon film	2.2kΩ±10%	¼SD	T 204	0326028	FM Discriminator		
R 721	0137856	Carbon film	2.7kΩ±10%	¼SD	T 205	0322115	AM IFT	20kΩ:0.3kΩ	
R 722	0137856	Carbon film	2.7kΩ±10%	¼SD	T 206	0322120	AM IFT	10kΩ:5kΩ	
R 723	0137769	Carbon film	68Ω±10%						
R 724	0137801	Carbon film	100Ω±10%	¼SD					
R 725	0111236	Metal oxide	270Ω±10%	1PB					
R 726	0111233	Metal oxide	150Ω±10%	1PB					
P C 102	0186415	CR pack	82kΩ, 0.001μF						
P C 201	0186385	CR pack	10kΩ×2, 0.001μF×2						
P C 202	0186386	CR pack	1kΩ×1, 100pF×2						
P C 203	0186514	CR pack							
R V 301	0151882	Semi variable	470Ω						

Symbol No.	Stock No.	Description	Symbol No.	Stock No.	Description
COILS:					
L 101	5123271	FM Trap		8721406	Flat screw-3mm ϕ \times 6mm (4 req'd) for front metal assembly mounting
L 102	5123119	FM RF			
L 103	5126006	FM RF	21	5632911	Lever switch (AFC, MODE & HI-FILTER)
L 104	5123271	FM Trap	22	5632931	Lever switch (POWER)
L 105	0318041	FM Oscillator		8721406	Flat screw 3mm ϕ \times 6mm (8 req'd) for lever switch mounting
L 106	5152012	Choke			
L 151	5112553	Feritte core Antenna	23	6392641	Pointer assembly
L 152	5120174	AM Oscillator	24	5762031	Lamp for pointer
			25	5552092	Tuning meter
L 304	5120183	19kHz Tuner	26	5671631	Headphone jack
L 305	5120189	38kHz Tuner	27	6345001	Pulley
L702A,B	5120303	Trap	28	6316231	Spring for pulley
L 704	5260054	Oscillator	29	6724792	U joint (2 req'd) for shaft (B)
		for Final assembly	30	7532385	Shaft (B) for function selector and slide switch
①	6129131	Bottom cover	31	7760121	Spacer (A) for lever switch
②	7260561	Bracket (B) for bottom cover		7232485	Antenna supporter
	8711610	Pan head screw-4mm ϕ \times 10mm (11 req'd) for chassis assembly mounting		8781438	Tapping screw-3mm ϕ \times 8mm (2 req'd) for antenna supporter mounting
	8721406	Flat screw-3mm ϕ \times 6mm (2 req'd) for front metal mounting		8781636	Tapping screw 4mm ϕ \times 6mm (2 req'd) for power transformer mounting
	8811116	Washer-4mm ϕ (2 req'd) for cassette deck assembly mounting	32	5741666	Power cord with plug
③	6274991	Selector knob (FUNCTION)	33	0043793	Bushing for power cord
④	6274971	Knob (TUNING)	34	7197661	Holder for power cord
⑤	6272022	Knob (LEVEL (left & right))	35	0043791	Cord cover
	6310162	Spring washer (4 req'd) for knob mounting	36	5680682	Antenna terminal plate
⑥	6267946	Slide knob (BASS, TREBLE, BALANCE, & LOUDNESS)		0532127	Slide switch (2 ch/4 ch selector)
⑦	7125212	Top metal assembly		0721305	Flat screw-2.6mm ϕ \times 5mm (2 req'd) for slide switch mounting
	6180201	Dust cover assembly		5651261	4P socket L=220 for between HF-1 P.W.B and jack
⑧	6619662	Metal for dust cover		5650601	4P socket L=100 for between TONE P.W.B and AF P.W.B
⑨	6170481	Cover for pin jack		5650772	3P socket L=500 for between AF P.W.B and headphone
	6191146	Rear cover			for Chassis assembly (B)
	7777257	Tapping screw-3mm ϕ \times 8mm (4 req'd) for rear cover mounting	37	7252704	Head plate assembly
	0040045	Lock washer	38	7252951	Head plate holder (A)
	8711616	Pan head screw-4mm ϕ \times 16mm (6 req'd) for bottom cover mounting	39	6324535	Head plate spring
		for Chassis assembly (A)	40	8641406	Bind screw-3mm ϕ \times 6mm for head plate holder (A) mounting
⑩	5720264	Fuse (3A)	41	7151831	Brake plate assembly
⑪	5680823	4P terminal plate	42	6309031	Brake spring
	8781438	Tapping screw-3mm ϕ \times 8mm (13 req'd) for P.W.B mounting	43	6725602	Idler assembly
	8721406	Flat screw-3mm ϕ \times 6mm (8 req'd) for Tone P.W.B. mounting	44	6324474	Idler spring
⑫	7258742	Bracket for switch	45	7253311	Brake function plate assembly
	8786438	Flat screw-3mm ϕ \times 8mm (4 req'd) for bracket mounting	46	6324451	Brake function plate spring
⑬	7722542	Reflector plate for pilot lamp	47	6725593	Pulley assembly
⑭	5760711	Pilot lamp (5 req'd) for scale plate illumination	48	6324582	Spring for fast forward
⑮	7669421	Holder (2 req'd) for pilot lamp	49	6324602	Spring for rewind
⑯	6462951	Scale plate assembly	50	6323731	Stop lever spring
⑰	5760742	Pilot lamp (2 req'd) for tape & phono		6325301	Spring (B) for pulley
⑱	5760346	Lamp for stereo		7230901	"E" ring for pulley assembly mounting
	6715061	Roller-13mm ϕ		7771912	Nylon washer for flywheel assembly mounting
	7777603	Screw (3 req'd) for roller mounting	51	6370991	Flywheel assembly
⑳	6621012	Front metal assembly		7778183	Polyester washer for flywheel mounting
			52	7254451	Flywheel supporting plate assembly
				8641408	Bind screw-3mm ϕ \times 8mm for flywheel supporting plate assembly mounting
			53	7252801	Flywheel supporting plate
				8711408	Pan head screw-3mm ϕ \times 8mm (2 req'd) for flywheel supporting plate mounting
			54	6725771	Take up arm assembly
			55	6324444	Spring for take up arm

Symbol No.	Stock No.	Description	Symbol No.	Stock No.	Description
56	7669222	Turntable assembly (A) for rewind			for Cassette deck assembly
57	0930002	Cap (2 req'd) for turntable (A), (C)	81	6727771	Cassette lid
58	0948832	Polyester washer (2 req'd) for turntable (A), (C) mounting	82	6129091	Decoration plate assembly with cassette lid
59	6712251	Turntable assembly (C) for take up	83	6727691	Lid stopper (2 req'd) for cassette door assembly
60	7252991	Pressure roller arm assembly	84	6326002	Spring for cassette door assembly mounting
	7230901	"E" ring for pressure roller arm assembly mounting		8745410	Bind screw-3mm ϕ \times 10mm (2req'd)
61	6324482	Spring for pressure roller arm assembly		8711406	Pan head screw-3mm ϕ \times 6mm
62	7252902	Record prevention plate		8781438	Tapping screw-3mm ϕ \times 8mm (3 req'd) for decoration plate assembly mounting
63	6324432	Spring for record prevention plate			for Deck chassis assembly
64	6320731	Spring for back tension	84	7253036	Eject arm assembly
65	7252914	Lock plate		8641406	Bind screw-3mm ϕ \times 6mm (3 req'd) for C.D P.W.B mounting
66	7259353	Pick up plate assembly	85	7252933	Eject function plate
	7230901	"E" ring for pick up plate assembly mounting		8641410	Bind screw-3mm ϕ \times 10mm for eject function plate mounting
67	6324464	Spring for pick up lock plate	86	7253276	Recording plate assembly
68	6725692	Head stand		6324501	Spring for recording plate
69	7252922	Stop lever		7252831	Recording prevention arm
70	5440093	Record/playback head		6324681	Spring for recording prevention arm
71	5441381	Erase head	88	6725621	Pulley for counter
	8715112	Pan head screw-2mm ϕ \times 12mm (4 req'd) for erase head and record/play back head mounting		6340231	Counter pulley
72	6321733	Head spring for record playback head	89	8715104	Pan head screw-2mm ϕ \times 4mm for counter pulley mounting
	0923972	Staple assembly	90	7252971	Holder for counter
73	7252811	Pause slider assembly		5550176	Counter
74	6725701	Pause lock piece		8711406	Pan head screw-3mm ϕ \times 6mm (2 req'd) for counter mounting
	7230902	"E" ring for pause slider assembly mounting		8641406	Bind screw-3mm ϕ \times 6mm for counter holder mounting
75	5571201	Motor	91	6351021	Counter belt-1"
76	7252762	Motor holder	92	7253191	Switch holder
77	6342273	Motor pulley		8641406	Bind screw-3mm ϕ \times 6mm for switch holder mounting
	7771152	Set screw	93	5632043	Micro switch
	8711405	Pan head screw-3mm ϕ \times 5mm		8715112	Pan head screw-2mm ϕ \times 12mm (2 req'd) for micro switch mounting
	8711610	Pan head screw-4mm ϕ \times 10mm for motor mounting	94	5632172	Bar switch
78	7662211	Cushion (2 req'd) for motor		8641406	Bind screw-3mm ϕ \times 6mm
	0681276	Washer-3mm ϕ (3 req'd) for motor mounting		8815124	Lock washer-3mm ϕ for bar switch mounting
	6725661	Motor holder stand	95	7532961	Switch function wire
79	7500213	Collar (2 req'd) for motor		6324902	Lever spring (MC)
	8641416	Bind screw-3mm ϕ \times 16mm (3 req'd) for motor mounting	96	8711404	Pan head screw-3mm ϕ \times 4mm for pause plate mounting
80	7667611	Belt for flywheel	97	7252941	Pause plate
	8641406	Bind screw-3mm ϕ \times 6mm for power P.W.B assembly mounting	98	6275251	Button assembly
	7253212	Holder for P.W.B		8641406	Bind screw-3mm ϕ \times 6mm (2 req'd) button assembly mounting
	8641406	Bind screw-3mm ϕ \times 6mm for holder mounting		8641406	Bind screw-3mm ϕ \times 6mm (2 req'd) for sub chassis mounting
			99	7677034	Cushion for level meter
			100	6480681	Meter plate
			(101)	5551943	Level meter
				8744406	Bind screw-3mm ϕ \times 6mm for meter plate mounting
				7677033	Cushion (2 req'd) for level meter
			(102)	5760741	Lamp (2 req'd) for level meter
			(103)	0971002	Rubber cushion (2 req'd) for lamp
				7760131	Spacer (M) for meter plate
				7263101	P.W.B holder assembly (B) for deck (left side)
				8641406	Bind screw-3mm ϕ \times 6mm (3 req'd) for P.W.B holder assembly (B) mounting
				8641406	Bind screw-3mm ϕ \times 6mm (2 req'd) for deck holder mounting

Symbol No.	Stock No.	Description	Symbol No.	Stock No.	Description
(104)	7263081	P.W.B holder (A) for deck (rear)			for P.W.B. assembly
	8641406	Bind screw-3mm \varnothing \times 6mm for P.W.B holder (A)	5610633	Rotary switch with micro switch	
	5670461	Microphone jack	5651255	3P Socket L=470 for JACK P.W.B assembly	
	5671711	Microphone jack with switch			
	5746015	3P Socket (Brown: L=270)	8781436	Tapping screw-3mm \varnothing \times 6mm (4 req'd) for between radiator and P.W.B	
	5746025	3P Socket (Black: L=270)	8781442	Tapping screw-3mm \varnothing \times 12mm (4 req'd) for between IC and radiator	
	0948896	Washer	5720221	Fuse holder	
	0948771	Insulating washer } (2 req'd) for microphone jack mounting			
	5650771	3P Socket L=250 (2 req'd) for between REC volume and C.D P.W.B	5621191	Slider switch	
	5650781	4P Socket L=250 for between meter and C.D P.W.B	6323141	Spring clip	
5650881	3P Connector L=330 for between AC motor and AC cord				



Head Office : 5-1,1 chome, Marunouchi, Chiyoda-ku, Tokyo
: Tel. Tokyo (212) 1111 (80 lines)
Cable Address : "HITACHY" TOKYO
Codes : All Codes Used

Printed in Japan
Jan. '74 (K)